

TIREE 500



EN - This tent should be erected by at least 2 people

CZ - Tento stan by měl být postaven nejméně 2 osobou

DE - Dieses Zelt sollte von mindestens zwei Personen aufgestellt werden

FR - Cette tente doit être érigée par au moins 2 personnes

IT - Questa tenda deve essere eretto da almeno 2 persone

NL - Deze tent moet worden omgeven door minstens 2 personen

PITCHING

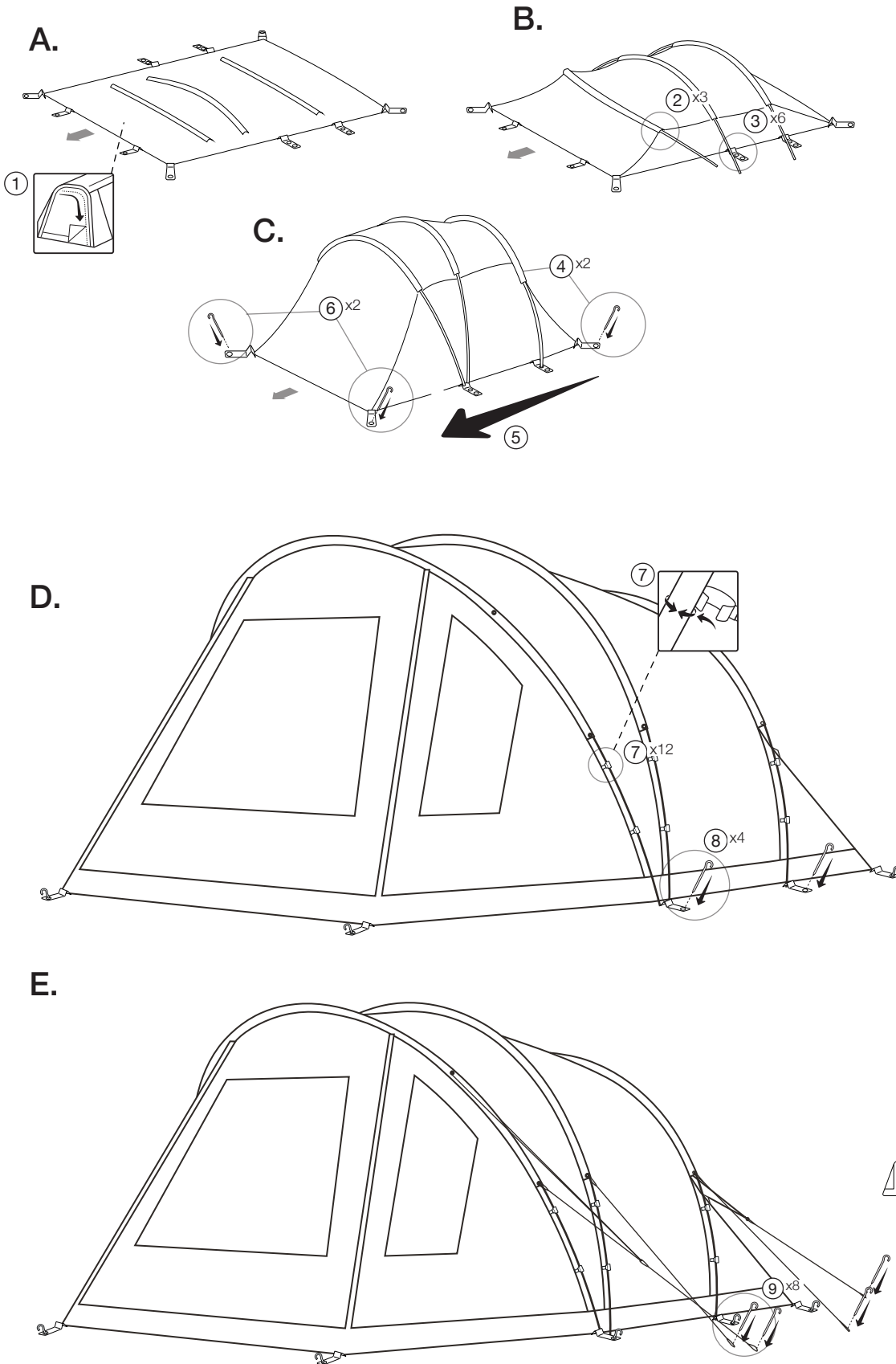

Poles

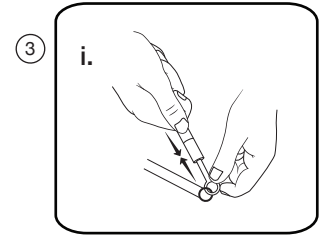
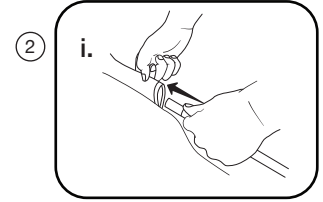

TBS® II

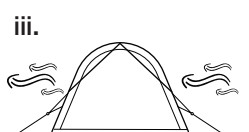
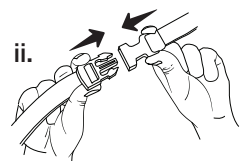

TIREE 500



EN - This tent should be taken down by at least 2 people

CZ - Těto stan by měl být sundán nejméně 2 osoby

DE - Dieses Zelt sollte von mindestens zwei Personen heruntergenommen werden

FR - Cette tente doit être prise par au moins 2 personnes

IT - Questa tenda deve essere assunta verso il basso da almeno 2 persone

NL - Deze tent moet door minstens 2 personen worden genomen

TAKING DOWN & PACKING

A.

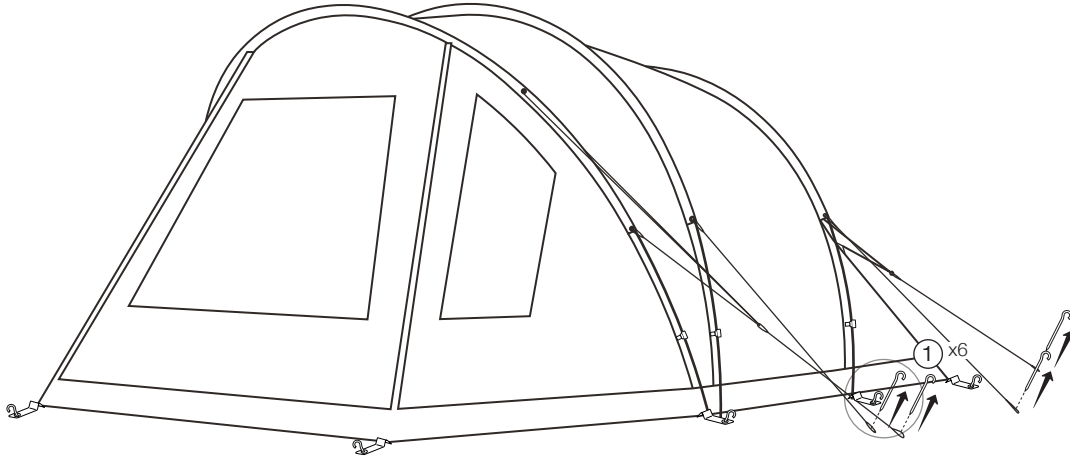

Poles

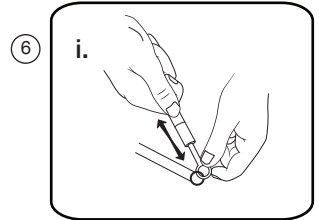

B.

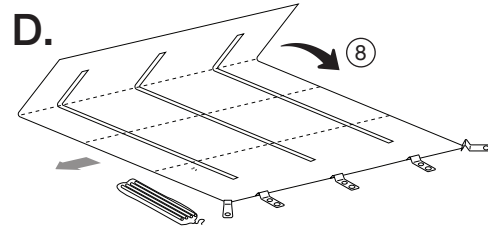
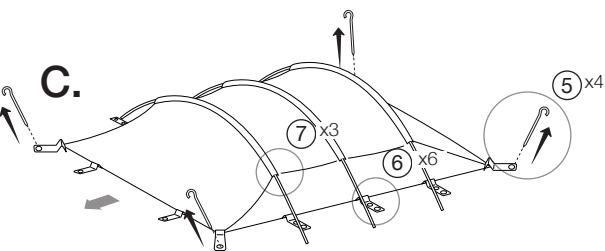
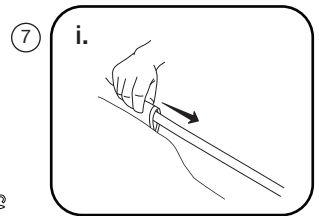
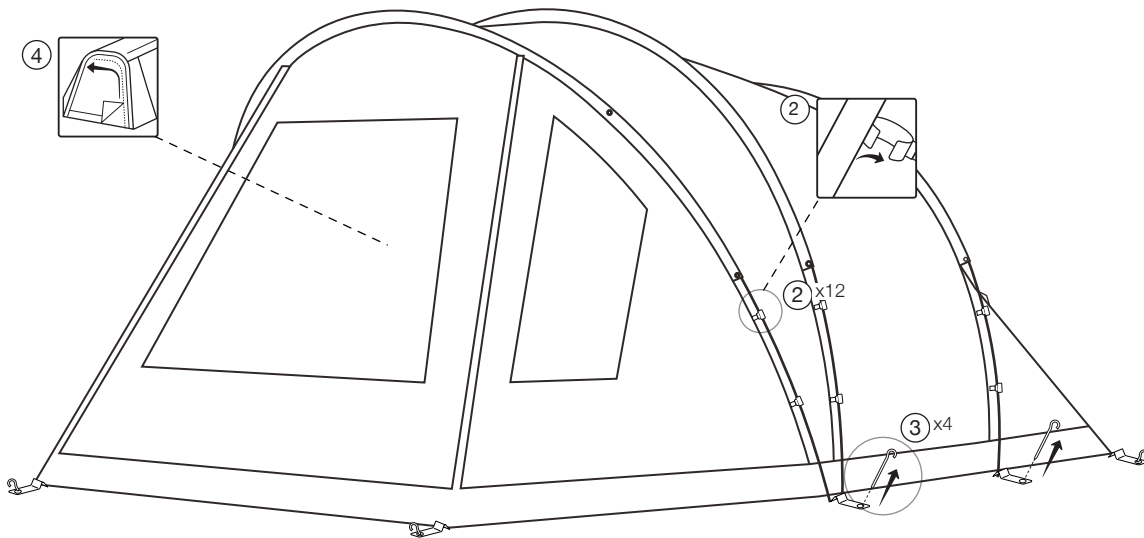

E.

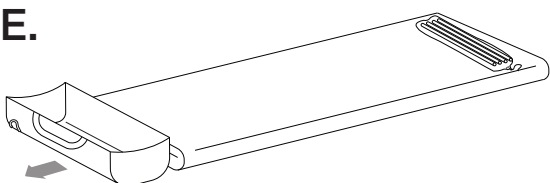

F.

